

Impacts of Placement of Wind Turbine Generators on IEEE 13 Node Radial Test Feeder In-Line Transformer Fuse-Fuse Protection Coordination

Kemei Peter Kirui, David K. Murage, and Peter K. Kihato

Abstract—The ever increasing global demand on the electrical energy has led to the integration of Distributed Generators (DGs) onto the distribution power systems networks to supplement on the deficiencies on the electrical energy generation capacities. The high penetration levels of DGs on the electrical distribution networks experienced over the past decade calls for the grid operators to periodically and critically assess the impacts brought by the DGs on the distribution network operations. The assessment on the impacts brought by the DGs on the distribution network operations is done by simulating the dynamic response of the network to major disturbances occurring on the network like the faults once the DGs have been connected into it. Connection of Wind Turbine Generators (WTGs) into a conventional electrical energy distribution network has great impacts on the short circuit current levels experienced during a fault and also on the protective devices used in protecting the distribution network equipment namely; the transformers, the overhead distribution lines, the underground cables and the line compensators and the shunt capacitors commonly used/found on the relatively long rural distribution feeders. The main factors which contribute to the impacts brought by the WTGs integration onto a conventional distribution network are: The location of interconnecting the WTG/s into the distribution feeder; The size/s of the WTG/s in terms of their electrical wattage penetrating the distribution network; And the type of the WTG interfacing technology used labeled/classified as, Type I, Type II, Type III and Type IV WTGs. Even though transformers are the simplest and the most reliable devices in an electrical power system, transformer failures can occur due to internal or external conditions that make the transformer incapable of performing its proper functions. Appropriate transformer protection should be used with the objectives of protecting the electrical power system in case of a transformer failure and also to protect the transformer itself from the power system disturbances like the faults. This paper was to investigate the effects of integrating WTGs on a distribution transformer Fuse-Fuse conventional protection coordination scheme. The radial distribution feeder studied was the IEEE 13 node radial test feeder and it was simulated using the Electrical Transient Analysis Program (ETAP) software for distribution transformer Fuse-Fuse protection coordination analysis. The IEEE 13 Node radial test feeder In-line transformer studied is a three-phase 500kVA step down transformer having a star solidly grounded primary winding supplied at 4.16kV and a star solidly grounded secondary winding feeding power at a voltage of 0.48kV. The increase on the short circuit currents at the In-line transformer nodes due to the WTG integration

continuously reduces the time coordination margins between the upstream fuse F633 and the downstream fuse F634 used to protect the transformer.

Index Terms—In-Line Transformer, Single-Line-to-Ground Faults, Three Phase Faults, Fuse-Fuse Protection Coordination, TCC Protection Coordination Curves, Time Coordination Margin, Fuse F633 and Fuse F634 Coordination.

I. TRANSFORMER PROTECTION REQUIREMENTS

In order to effectively protect a power systems distribution network transformer and implement the fuse-fuse protection scheme, transformer protective devices must be set within the *NEC* 450.3 requirements for transformer overload protection to allow for the normal magnetizing inrush currents to flow [1]. The transformer primary side protective devices must not operate for the normal magnetizing inrush currents that occur when energizing the transformer [2]. The magnetizing inrush points are established at 8 times the transformer full load current (FLA) for a period of 0.1 seconds for transformers under 2500kVA and for transformers above 2500kVA the inrush point is at 10 or 12 times the transformer FLA for a period of 0.1 seconds [3][4]. The transformer protection coordination constraints are [5]:

- Transformers having percentage impedances less than 10% on the primary/source side of the transformer, the primary side protection must have an upstream fuse rated at 300% of the transformer full load currents. [5]
- Transformers rated over 1000V on the secondary/load side and having percentage impedances less than 6% on secondary side of the transformer, the load side protection must have a downstream fuse rated at 250% of the transformer full load currents. [5]
- Transformers rated over 1000V on the secondary/load side and having percentage impedances between 6% – 10% on the secondary side of the transformer, the load side protection must have a downstream fuse rated at 225% of the transformer full load currents. [5]
- Transformers rated less than 1000V on the secondary/load side and having percentage impedances less than 10% on the secondary side of the transformer, the load side protection must have a downstream fuse rated at 125% of the transformer full load currents. [5]

Published on June 7, 2020.

K. P Kirui, Department of Electrical and Electronic Engineering, JKUAT, Kenya. (e-mail: kemei.kirui@mu.ac.ke or kemei.kirui@gmail.com)

D. K. Murage, Department of Electrical and Electronic Engineering, JKUAT, Kenya. (e-mail: dkmurage25@yahoo.com).

P. K Kihato, Department of Electrical and Electronic Engineering, JKUAT, Kenya. (e-mail: pkihato@jkuat.ac.ke).

II. TRANSFORMER FULL LOAD AMPERE MARK, MAGNETIZING INRUSH POINTS AND DAMAGE CURVES

A. The Transformer Full Load Ampere (FLA)

The full load ampere (FLA) is the rated continuous current carrying capacity of a transformer at a referenced ambient temperature and allowable temperature rise. The FLA mark is located on the transformer TCC log-log graph at the top decade at the 1000 seconds mark as seen from Fig 1. The transformer mechanical damage curve is shown located at the 3rd and 4th decade of the TCC Curve starting at the 2seconds mark to the 4 seconds mark as seen in Fig. 1. The thermal damage curve is shown located at the 3rd and 4th decade of the TCC coordination curve starting from the 2seconds mark to the 1000 seconds mark as shown in Fig. 1 [6].

B. The Transformer Through-Fault Damage Curves

Transformer through-fault damage curves are plotted at the top three decades of the transformer TCC log-log graph from the 2 seconds mark to the 1000 seconds mark. The transformer through fault damage curves are both the thermal and mechanical damage curves as seen from Fig. 1. [6].

C. The Transformer Magnetizing Inrush Current Point(s)

One or more transformer magnetizing inrush current points may be plotted on a TCC for a power transformer. These magnetizing inrush currents points are expressed in peak amperes with the most common point being at 8 or 12 times the rated FLA at 0.1 seconds mark and at 25 times of the rated FLA at 0.01 seconds mark as seen from Fig 1.. [6].

D. Transformer Protection Settings (From Fig. 2)

Step 1: Identify the Transformer TCC Curve Landmarks

- The Full Load Ampere point which is located at the upper decade at the 1000seconds mark.
- The Thermal Damage Curve which is located in the upper 3 decades starting at the 2 seconds mark to the 1000seconds mark
- The Mechanical Damage Curve which is located in the middle decade between the 2 seconds mark and the 4 seconds mark.
- The magnetizing inrush point defined at 8 or 12 times the FLA located at the 0.1 seconds mark and at the 25 times of the FLA mark located at the 0.01 seconds mark.

Step 2: Identify from the TCC Curves the Transformer Operating Area. (From Fig. 2)

- The transformer operating area is located to the left and below the full load ampere mark and also to the left and below the transformer magnetizing inrush points
- The transformer damage area is located to the right and above the through-fault damage curves both the thermal damage curve and the mechanical damage curve.

Step 3: Size and Set the Over-Current Protective Devices. (From Fig. 2)

- Set the protective device's TCC Curves above the transformer full load ampere mark and also above the transformer magnetizing inrush points. [7].

- Set the protective device's TCC Curves below both the transformer thermal and mechanical through-fault damage curves.

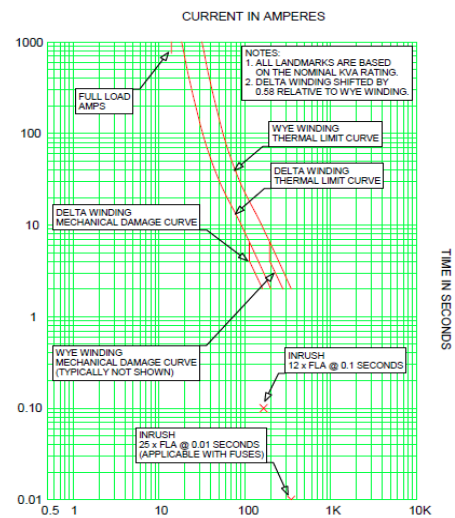

Fig. 1. Transformer Full load Ampere Mark, Magnetizing Inrush Points, Mechanical and Thermal Damage Curves

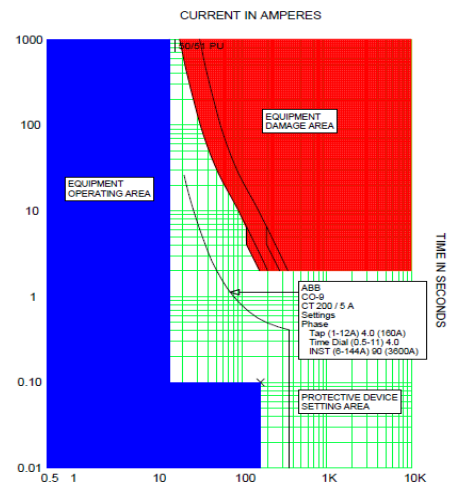

Fig. 2. Transformer Protection Setting TCC and OCPDs Curves

III. WIND TURBINE GENERATOR SHORT-CIRCUIT BEHAVIORS

A synchronous machine for short circuit modeling can be represented with a Thevenin equivalent circuit where the voltage and impedance represent the worst-case condition which is the highest short-circuit current contribution immediately following a fault. Fig. 3 shows the Thevenin's equivalent of a synchronous machine having a sub-transient reactance equivalent of X_d'' [8].

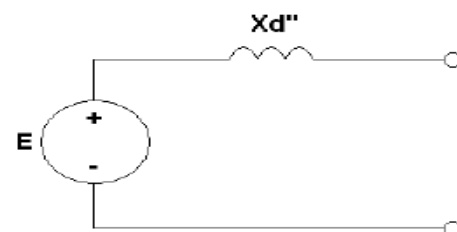

Fig. 3. Synchronous Machine Short-Circuit Equivalent.

Wind power plants on the other hand do not employ these types of machines for energy production. Wind power plants

either employ an induction machine with a direct connection to the main electrical grid, or they decouple the wind turbine generator from the main grid through power electronic devices [11].

A. Type I WTG Short-Circuit Model

The major difference between an induction machine and synchronous machine in regard to their behavior during a fault is their method of excitation. In a synchronous machine the excitation is provided from an independent DC source that is unaffected by a fault on the AC system. Due to this separate excitation, a synchronous machine will continue to supply high transient currents throughout the duration of a fault [9]. In contrast to this, the drop in the line voltage caused by a fault will cause the induction machine to lose excitation hence it only supplies transient currents to the fault for one or two cycles. Most induction machines on the electric power grid are small enough that their contribution to the fault current can be neglected, however the induction machines used in a Type I WTG are large enough that they are taken into account for determining the total fault current. The equivalent machine impedance for fault calculations is the sum of the stator and rotor reactances as shown in Fig. 4 [9].

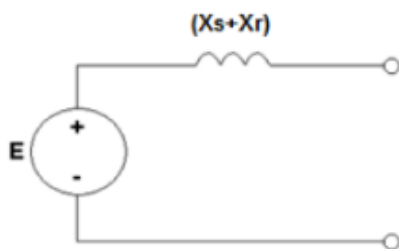

Fig. 4. Induction Machine Short Circuit Equivalent.

B. Type II WTG Short-Circuit Model

The addition of the external rotor resistance to a type II WTG acts as an impedance in the short circuit equivalent circuit, thus lowering the maximum available fault current of the induction machine [8]. However, the Type II wind turbine generator is operated such that the external rotor resistance is applied only when necessary since the losses in the resistor equate to lost energy production from the generator. This makes the short-circuit behavior for a Type II WTG machine similar to that of a Type I WTG machine. The same equivalent circuit for a Type I WTG machine shown in Fig. 4 is also used for a Type II WTG machine [10].

C. Type III WTG Short-Circuit Model

The short-circuit behavior of Type III WTG is modeled differently depending on the method used for the protection of the rotor power converter. Fig. 5 and Fig. 6 shows the two methods used to protect the power converter on the rotor circuit [8]. Early designs of the Type III WTG used a crowbar circuit that is activated during the initial phase of a fault. The crowbar circuit diverts the short-circuit currents away from the power converter, essentially shorting out the rotor windings. The removal of the power converter during a fault makes the Type III WTG behave similar to the Type I WTG and Type II WTG design, where worst case short-circuit current is based on the internal impedance of the

induction machine [8]. The other method of protecting the rotor converter is done with a chopper circuit. With a chopper circuit, better grid support is achieved during a fault by keeping the rotor converter active, but still limiting the currents to protect the sensitive power electronic devices within the power converters. When this method is used the short-circuit contribution from a Type III WTG is similar to that of a Type IV WTG and the equivalent circuit shown in Fig. 6 [9].

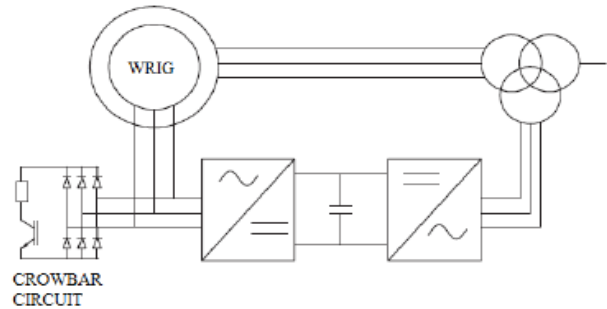

Fig. 5. Type III Wind Turbine Generator Crowbar Protection of the Power Converter

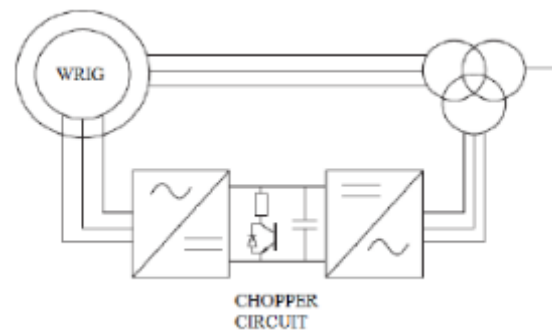

Fig. 6. Type III Wind Turbine Generator Chopper Protection of the Power Converter

D. Type IV WTG Short-Circuit Model

Unlike the type I, type II and type III designs where the short-circuit behavior was dominated by the generator characteristics; it is the design of the power converter that drives the electrical behavior of the Type IV WTG. The power converter in the Type III design is sensitive to excessive currents, so too is the converter in a Type IV WTG design. In order to protect the power electronics devices a current limit of 1.1pu is designed into the power converter [8]. Rather than the common voltage source behind impedance short-circuit equivalent used to model most generators, the Type IV WTG is a simple current source designed for maximum short-circuit contribution as shown in Fig. 7 [9].

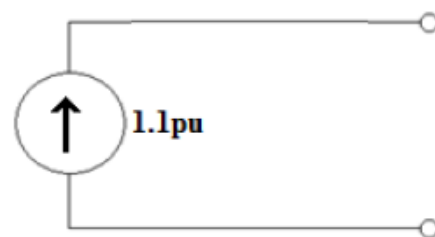

Fig. 7. Type IV WTG Short-Circuit Equivalent

IV. IEEE 13 NODE RADIAL TEST FEEDER FUSE-FUSE PROTECTION COORDINATION SCHEME ETAP MODEL

A. IEEE 13 Node Radial Test Feeder One-Line Diagram

The IEEE 13 node radial test feeder is a short, unbalanced and relatively highly loaded 4.16kV feeder. The features of the IEEE 13 node radial test feeder is basically the presence of: A 5000kVA 115kV/4.16kV Delta/Star substation transformer connected to the swing/grid node; One substation voltage regulator consisting of three single phase units connected in star; Eight overhead distribution lines and two underground cables with variety of lengths and phasing; Unbalanced delta and star connected distributed and spot loads; Two shunt capacitor banks one having a single phase connection at node 611 and the other a three phase connection at node 675; and a 500kVA 4.16kV/0.48kV star/star solidly grounded in-line transformer connected between node 633 and node 634. Fig. 8 shows the schematic layout of the IEEE 13 node radial test feeder used as the model which was simulated without showing the nature and configuration of the distribution components of the network [10].

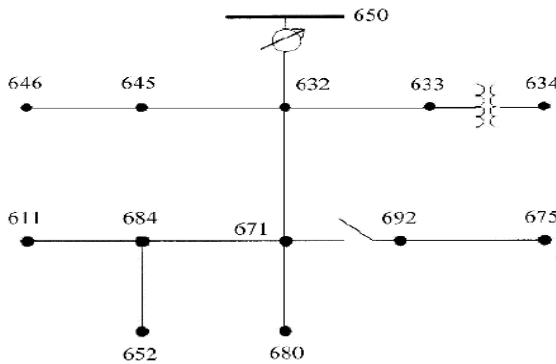

Fig. 8. The IEEE 13 Node Radial Test Feeder Schematic Diagram

IEEE 13 node radial test feeder was modeled using ETAP electrical simulation software. A one line diagram was drawn for the feeder and fuses modeled as both the upstream and downstream OCPDs for protecting the radial test feeder as shown in Fig. 9. A protection scheme utilizing a total of 23 fuses was modeled for the feeder protection. Each component on the feeder had a fuse as its downstream OCPD with the fuse generally referred to as the load fuse. An upstream fuse was also modeled and set to coordinate with the downstream fuse for the feeder protection. The fuse's current ratings, voltage limits and TCC curves were carefully selected so that we achieve a selectively coordinated Fuse-Fuse protection scheme for the feeder. [11].

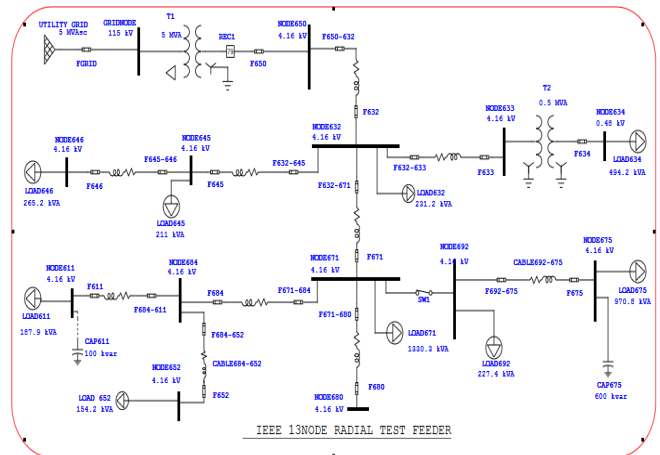

Fig. 9. IEEE 13 Node Radial Test Feeder Fuse Protection Scheme One-Line Diagram

B. The IEEE 13 Node Radial Test Feeder In-Line Transformer Full Load Ampere Mark, Magnetizing Inrush Points and Damage Curves

The In-line transformer is connected on the primary side to node 633 and on the secondary side to node 634 and is denoted as T2 in the one-line diagram. The transformer is protected by two fuses F633 at the high voltage side and fuse F634 at the low voltage side. The TCC Curve for the transformer and its protective fuses is shown in the Fig. 10. The TCC Curve shows that the transformer full-load ampere (FLA) of 601.407A is located at the upper decade at the 1000seconds mark and its magnetizing inrush current of 4811.253A with a multiplier 8 of the FLA located at the bottom decade at 0.1seconds mark of the TCC Curve. The transformer mechanical damage curve is shown located at the 3rd and 4th decade of the TCC Curve starting at the 2seconds mark to the 4 seconds mark. The thermal damage curve is also shown located at the 3rd and 4th decade of the TCC coordination curve starting from the 2seconds mark to the 50 seconds mark. [11].

Fuse F633 has a continuous current rating of 150A which is within the NEC 450.3 maximum limit of 300% of the transformer full load amperes (FLA) of 208.2A. NEC 450.3 stipulates that an upstream fuse used in protecting the transformer primary windings must have a rating not exceeding 300% of the primary side full load current. Fuse F633 trip curve is located above and to the right of the transformer full load current (FLA) of 69.4A and its magnetizing inrush current point of $8 \times FLA$ at 4811.253A. This clearly shows that the trip curve for fuse F633 protects the In-Line transformer's FLA mark and its magnetizing inrush current point.

Fuse F634 has a continuous current rating of 630A and is within the NEC 450.3 maximum limit which stipulates that a downstream fuse protecting the secondary windings of a transformer should have a current limit not exceeding 125% of the transformer full load currents. Fuse F634 continuous current rating of 630A is within NEC 450.3 maximum limit of 125% of the FLA of 751.8A..Fuse F634 trip curve is located below and to the left of both the transformer thermal damage curve and the transformer mechanical damage curves hence fuse F634 protects the In-Line transformer.

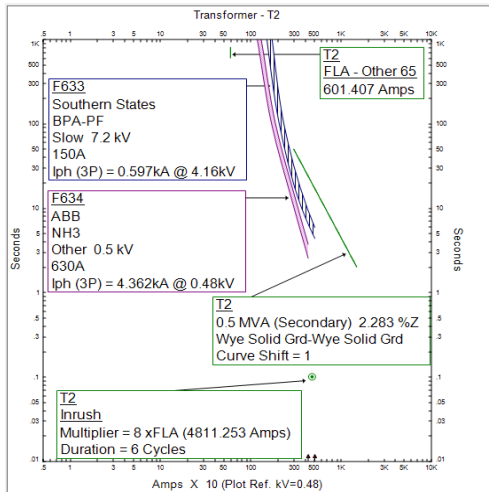

Fig. 10. In-Line Transformer Full Load Ampere Mark, Magnetizing Inrush Points, Mechanical and Thermal Damage Curves and Fuse F633 and F634 TCC Trip Curves

V. IMPACTS OF PLACEMENT OF WIND TURBINE GENERATORS ON IEEE 13 NODE RADIAL TEST FEEDER IN-LINE TRANSFORMER FUSE-FUSE PROTECTION COORDINATION

A. In-Line Transformer Fuse-Fuse Protection Coordination without WTG

TABLE I: FUSE F633 AND FUSE F634 COORDINATION WITHOUT WTG

Up-stream Fuse	Down-stream Fuse	Maximum Fault Current (A)		Coordination Time Margin in seconds	Current Coordination Range (A)	
		Type	Amp		From	To
F633	F634	3Ph	4362	2.75	945.1	4362
		L-G	5426	2.31	945.5	5426

From Table I, for a three phase fault at the secondary NODE634 of the In-Line transformer, fuse F633 and fuse F634 are coordinated with a time coordination margin of 2.75s and a current coordination range from 945.1A to the three phase short circuit fault current of 4362A as shown in Fig. 11 below.

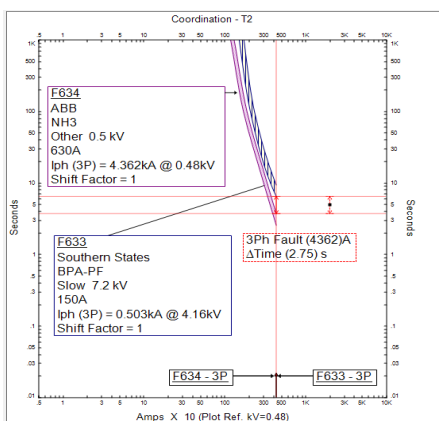

Fig. 11. Fuse F633 and Fuse F634 TCC Protection Coordination Curves for Three Phase Fault without WTG

From Table I, for a single-line-to-ground fault of magnitude 5426A at the secondary of the in-line transformer at node 634, F633 and F634 are coordinated with a time coordination margin of 2.31s and a current coordination range from 945.5A to the SLG short circuit fault current of 5426A as shown in Fig. 12 below.

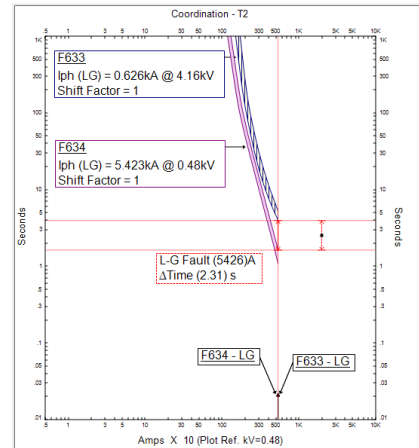

Fig. 12. Fuse F633 and Fuse F634 TCC Protection Coordination Curves for SLG Fault without WTG

B. In-Line Transformer Fuse-Fuse Protection Coordination with 1MW Type I/II/III WTG Connected at Node634

TABLE II: FUSE F633 AND F634 COORDINATION WITH 1MW TYPE I/II/III WTG CONNECTED AT NODE634

Up-Stream FUSE	Down-Stream FUSE	Maximum Fault Current (A)		Coordination Time Margin in seconds	Current Coordination Range (A)	
		Type	Amp		From	To
F633	F634	3Ph	4362	2.75	945.1	4362
		L-G	12014	1.85	1689	12014

From Table II, for a three phase fault at the secondary side at NODE634 of the In-Line transformer, fuse F633 and fuse F634 are coordinated with a time coordination margin of 2.75s and a current coordination range from 945.1A to the three phase short circuit fault current of 4362A as shown in Fig. 13 below.

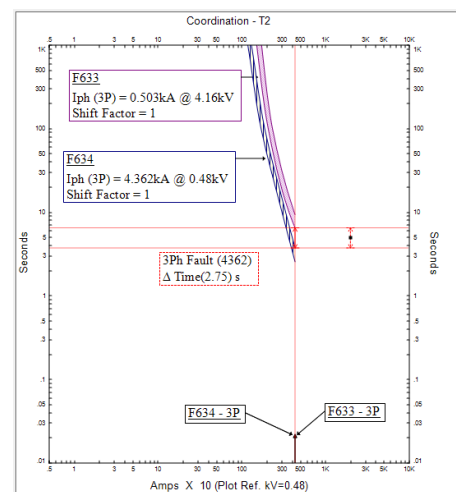

Fig. 13. Fuse F633 and Fuse F634 TCC Protection Coordination Curves for Three Phase Fault with 1MW Type I/II/III WTG Connected at NODE634

From Table II, for a single-line-to-ground fault of magnitude 12014A at NODE634, F633 and F634 are coordinated with a time coordination margin of 1.85s and a current coordination range from 1689A to the SLG short circuit fault current of 12014A as shown in Fig.14 below.

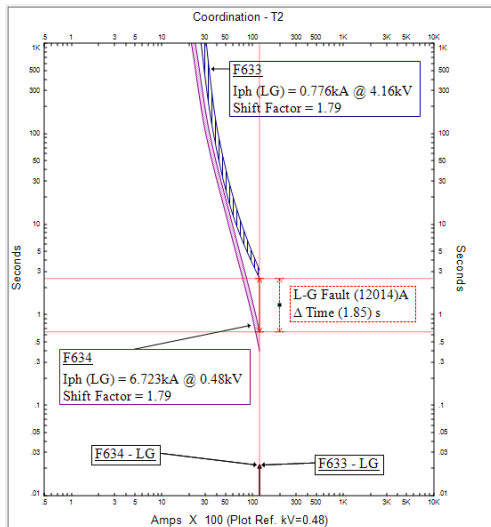

Fig. 14. Fuse F633 and Fuse F634 TCC Protection Coordination Curves for SLG Fault with 1MW Type I/II/III WTG Connected at NODE634.

C. In-line Transformer Fuse-Fuse Protection Coordination with 1MW Type I/II/III WTG Connected at Node 650

TABLE III: FUSE F633 AND F634 COORDINATION WITH 1MW TYPE I/II/III WTG CONNECTED AT NODE 650

Up-Stream FUSE	Down-Stream FUSE	Maximum Fault Current (A)		Coordination Time Margin in seconds	Current Coordination Range (A)	
		Type	Amp		From	To
F633	F634	3Ph	8211	1.4	945.1	8211
		L-G	8945	1.21	945.1	8945

From Table III, for a three phase fault at the secondary side at NODE634 of the In-Line transformer, fuse F633 and fuse F634 are coordinated with a time coordination margin of 1.4s and a current coordinating range from 945.1A to the three phase short circuit fault current of 8211A as shown in Fig. 15 below.

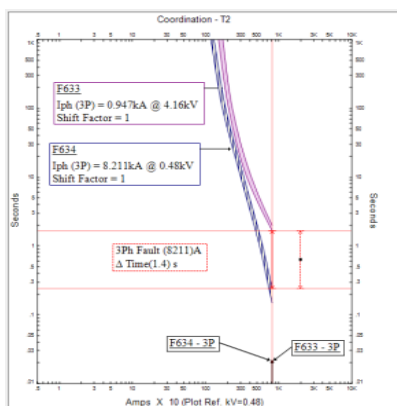

Fig. 15. Fuse F633 and Fuse F634 TCC Protection Coordination Curves for Three Phase Fault with 1MW Type I/II/III WTG Connected at NODE650

From Table III, for a single-line-to-ground fault of magnitude 8945A at NODE634, F633 and F634 are coordinated with a time coordination margin of 1.21s and a current coordination range from 945.1A to the SLG short circuit fault current of 8945A as shown in Fig. 16 below.

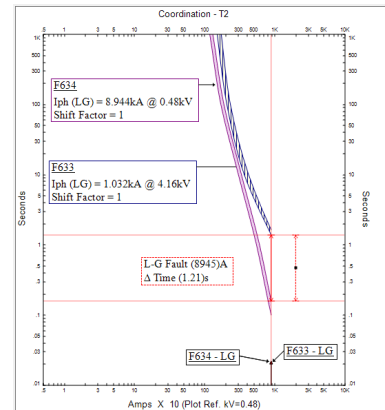

Fig. 16. Fuse F633 and Fuse F634 TCC Protection Coordination Curves for SLG Fault with 1MW Type I/II/III WTG Connected at NODE650

D. In-Line Transformer Fuse-Fuse Protection Coordination with 3MW Type I/II/III WTG Connected at Node634

TABLE IV: FUSE F633 AND F634 COORDINATION WITH 3MW TYPE I/II/III WTG CONNECTED AT NODE634

Up-Stream FUSE	Down-Stream FUSE	Maximum Fault Current (A)		Coordination Time Margin in seconds	Current Coordination Range (A)	
		Type	Amp		From	To
F633	F634	3Ph	4362	2.75	945.1	4362
		L-G	18638	1.46	2197	18638

From Table IV, for a three phase fault at the secondary side at NODE634 of the In-Line transformer, fuse F633 and fuse F634 are coordinated with a time coordination margin of 2.75s and a current coordination range from 945.1A to the three phase short circuit fault current of 4362A as shown in Fig. 17 below.

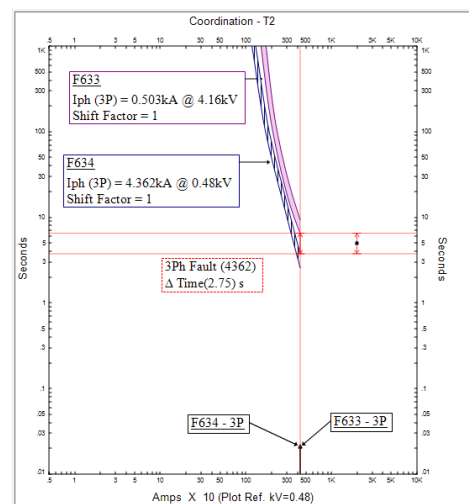

Fig. 17. Fuse F633 and Fuse F634 TCC Protection Coordination Curves for Three Phase Fault with 3MW Type I/II/III WTG Connected at NODE634

From Table IV, for a single-line-to-ground fault of magnitude 18638A at NODE634, F633 and F634 are coordinated with a time coordination margin of 1.46s and a current coordination range from 2197A to the SLG short circuit fault current of 18638A as shown in Fig. 18 below.

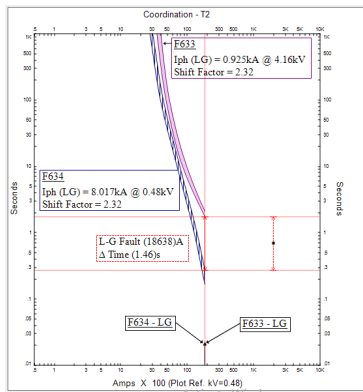

Fig. 18. Fuse F633 and Fuse F634 TCC Protection Coordination Curves for SLG Fault with 3MW Type I/II/III WTG Connected at NODE634

E. In-Line Transformer Fuse-Fuse Protection Coordination with 3MW Type I/II/III WTG Connected at Node 650

TABLE V: FUSE F633 AND F634 COORDINATION WITH 3MW TYPE I/II/III WTG AT NODE 650

Up-Stream FUSE	Down-Stream FUSE	Maximum Fault Current (A)		Coordination Time Margin in seconds	Current Coordination Range (A)	
		Type	Amp		From	To
F633	F634	3Ph	11973	0.692	945.1	11973
		L-G	11509	0.751	945.1	11509

From Table V, for a three phase fault at the secondary side at NODE634 of the In-Line transformer, fuse F633 and fuse F634 are coordinated with a time coordination margin of 0.692s and a current coordination range from 945.1A to the three phase short circuit fault current of 11973A as shown in Fig. 19 below.

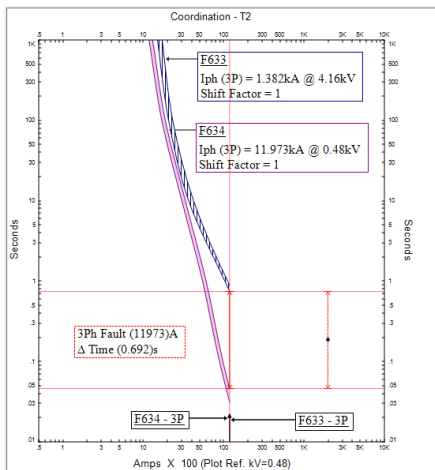

Fig. 19. Fuse F633 and Fuse F634 TCC Protection Coordination Curves for Three Phase Fault with 3MW Type I/II/III WTG Connected at NODE650

From Table V, for a single-line-to-ground fault of magnitude 11509A at NODE634, F633 and F634 are coordinated with a time coordination margin of 0.751s and a current coordination range from 945.1A to the SLG short circuit fault current of 11509A as shown in Fig. 20 below.

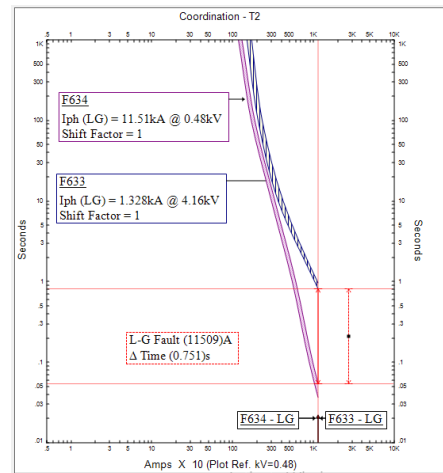

Fig. 20. Fuse F633 and Fuse F634 TCC Protection Coordination Curves for SLG Fault with 3MW Type I/II/III WTG Connected at NODE650.

F. In-line Transformer Fuse-Fuse Protection Coordination with 1MW Type IV WTG Connected at Node 650

TABLE VI: FUSE F633 AND F634 COORDINATION WITH 1MW TYPE IV WTG CONNECTED AT NODE 650

Up-Stream FUSE	Down-Stream FUSE	Maximum Fault Current (A)		Coordination Time Margin in seconds	Current Coordination Range (A)	
		Type	Amp		From	To
F633	F634	3Ph	4685	2.62	945.1	4685
		L-G	5748	2.19	945.5	5748

From Table VI, for a three phase fault at the secondary side at NODE634 of the In-Line transformer, fuse F633 and fuse F634 are coordinated with a time coordination margin of 2.62s and a current coordination range from 945.1A to the three-phase short circuit fault current of 4685A as shown in Fig. 21 below.

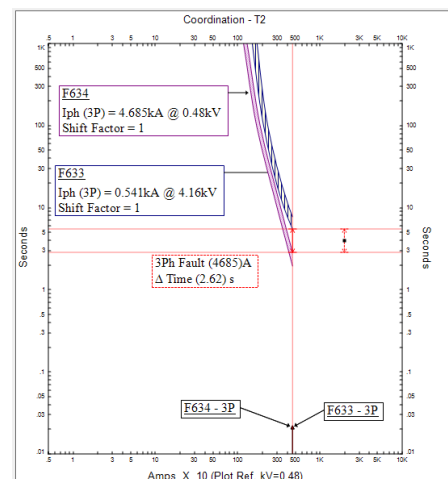

Fig. 21. Fuse F633 and Fuse F634 TCC Protection Coordination Curves for Three Phase Fault with 1MW Type IV WTG Connected at NODE650

From Table VI, for a single-line-to-ground fault of magnitude 5748A at NODE634, F633 and F634 are coordinated with a time coordination margin of 2.19s and a current coordination range from 945.5A to the SLG short circuit fault current of 5748A as shown in Fig. 22 below.

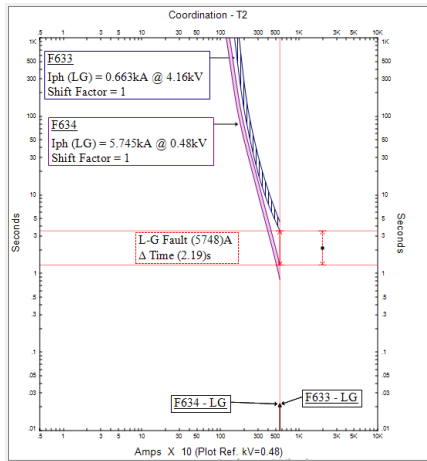

Fig. 22. Fuse F633 and Fuse F634 TCC Protection Coordination Curves for SLG Fault with 1MW Type IV WTG Connected at NODE650.

G. In-Line Transformer Fuse-Fuse Protection Coordination with 3MW Type IV WTG Connected at Node 650

TABLE VII: FUSE F633 AND F634 COORDINATION WITH 3MW TYPE IV WTG AT NODE 650

Stream FUSE	Down-Stream FUSE	Maximum Fault Current (A)		Coordination Time Margin in seconds	Current Coordination Range (A)	
		Type	Amp		From	To
F633	F634	3Ph	6225	2.01	945.1	6225
		L-G	7292	1.67	945.3	7292

From Table VII, for a three phase fault at the secondary side at NODE634 of the In-Line transformer, fuse F633 and fuse F634 are coordinated with a time coordination margin of 2.01s and a current coordination range from 945.1A to the three phase short circuit fault current of 6225A as shown in Fig. 23 below.

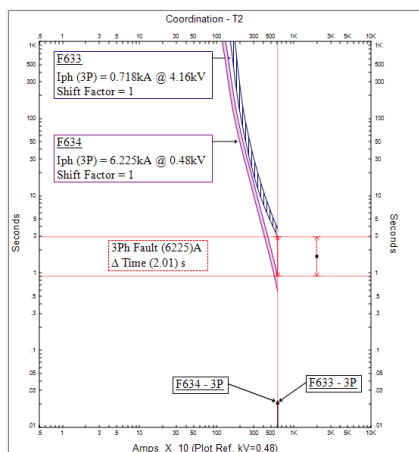

Fig. 23. Fuse F633 and Fuse F634 TCC Protection Coordination Curves for Three Phase Fault with 3MW Type IV WTG Connected at NODE650

From Table VII, for a single-line-to-ground fault of magnitude 7292A at NODE634, F633 and F634 are coordinated with a time coordination margin of 1.67s and a current coordination range from 945.3A to the SLG short circuit fault current of 7292A as shown in Fig. 24 below.

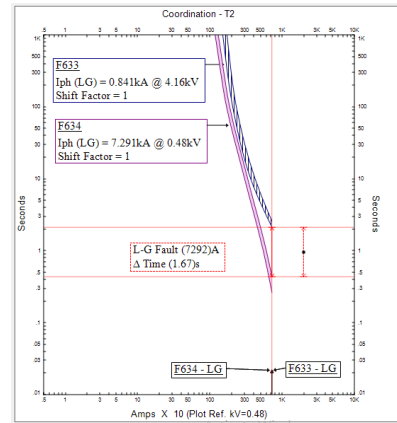

Fig. 24. Fuse F633 and Fuse F634 TCC Protection Coordination Curves for SLG Fault with 3MW Type IV WTG Connected at NODE650

VI. CONCLUSION

A. Short circuit fault currents at the secondary side of the In-Line Transformer

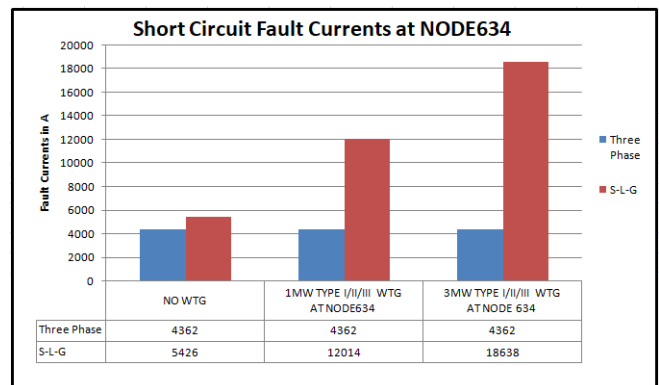

Fig. 25. Short circuit fault currents at NODE634 without WTGs and with 1MW and 3MW Type I/II/III WTGs Connected at NODE634

- From Fig. 25, there is no increase in the three phase fault currents at the secondary side of the in-line transformer when 1MW and 3MW Type I/II/III WTGs are connected at NODE634.
- From Fig. 25, there is a gradual and linear increase in the single-line-to-ground fault currents at the secondary side of the in-line transformer when 1MW and 3MW Type I/II/III WTGs are connected at NODE634

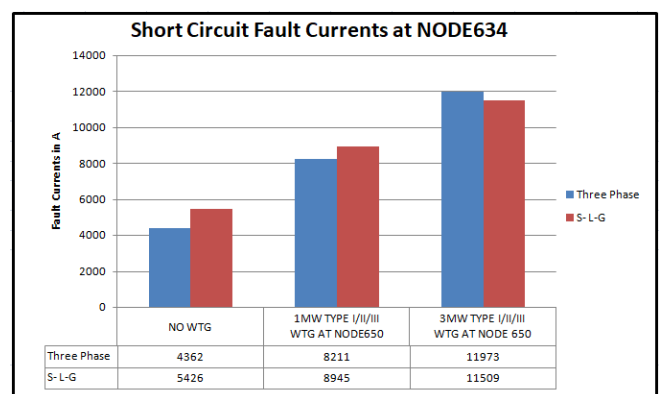

Fig. 26. Short circuit fault currents at NODE634 without WTGs and with 1MW and 3MW Type I/II/III WTGs Connected at NODE650

- From Fig. 26, there is a gradual and a linear increase in the three phase fault currents at the secondary side

of the in-line transformer when 1MW and 3MW Type I/II/III WTGs are connected at NODE650.

- From Fig. 26, there is a gradual and linear increase in the single-line-to-ground fault currents at the secondary side of the in-line transformer when 1MW and 3MW Type I/II/III WTGs are connected at NODE650.

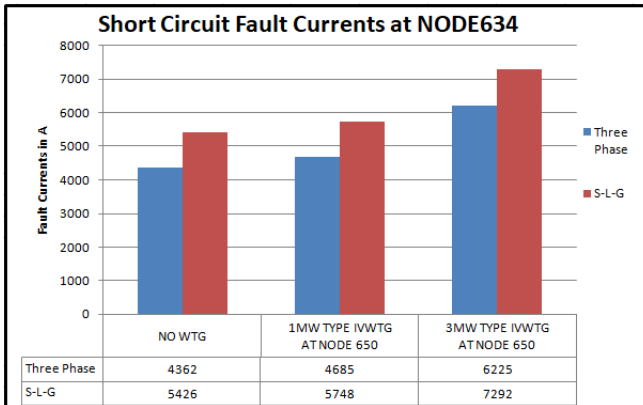

Fig. 27. Short circuit fault currents at NODE634 without WTGs and with 1MW and 3MW Type IV WTGs Connected at NODE650

- From Fig. 27, there is a gradual and a linear increase in the three phase fault currents at the secondary side of the in-line transformer when 1MW and 3MW Type IV WTGs are connected at NODE650.
- From Fig. 27, there is a gradual and linear increase in the single-line-to-ground fault currents at the secondary side of the in-line transformer when 1MW and 3MW Type IV WTGs are connected at NODE650

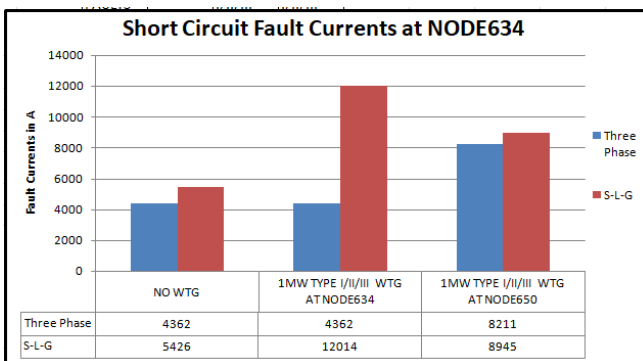

Fig. 28. Short circuit fault currents at NODE634 without WTGs and with 1MW Type I/II/III WTGs Connected at NODE634 and NODE650

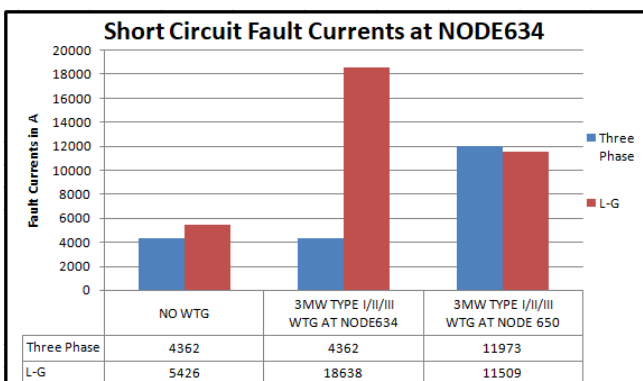

Fig. 29. Short circuit fault currents at NODE634 without WTGs and with 3MW Type I/II/III WTGs Connected at NODE634 and NODE650

- From Fig. 28 and 29, 1MW and 3MW Type I/II/III WTGs connected at NODE634 causes the highest increase in the single-line-to ground fault currents at the secondary side of the in-line transformer as compared to the increase brought about by 1MW and 3MW Type I/II/III WTGs connected at NODE650.
- From Fig. 28 and 29, 1MW and 3MW Type I/II/III WTGs connected at NODE650 causes the highest increase in the three phase fault currents at the secondary side of the in-line transformer as compared to the increase brought about by 1MW and 3MW Type I/II/III WTGs connected at NODE634.
- Type I/II/III WTGs Connected at NODE650 causes the highest increase in the single-line-to ground fault currents at the secondary side of the in-line transformer as compared to the increase brought about by Type IV WTGs connected at NODE650.
- There is coordination between fuse F633 and fuse F634 for all the scenarios studied.
- Solid grounding of transformers as an impact increase in the magnitudes of the single-line-to-ground fault currents as compared to the increase in the three phase faults.

B. Fuse F633 and Fuse F634 Time Coordination Margins

- There is diminishing/reduction on the time coordination margins between fuse F633 and fuse F634 as the capacity of the WTGs increases from 1MW to 3MW.
- WTG reduces the time coordination margin between the upstream fuse F633 and downstream fuse F634. The time coordination margins are diminishing towards the 0.025s margin where miss-coordination between an upstream and a downstream fuse is experienced.
- Type I/II/III WTGs connected at NODE650 causes the highest rate of reduction/diminishing of the time coordination margins between fuse F633 and fuse F634 as compared to Type I/II/III WTGs connected at NODE634.

REFERENCES

- [1] Jim Pauley " Application of Over-Current Protection Rules to Transformers and Primary and Secondary Conductors" Codes and Standards Application Data. Square D Company. Bulletin Number 011DB0201. USA. Technical Report.
- [2] KP Kirui, DK Murage, PK Kihato: *Impacts of Placement of Wind Turbine Generators with Different Interfacing Technologies on Radial Distribution Feeder Short Circuit Currents*. Proceedings of sustainable research and innovation conference. JKUAT, ISSN: 2079-6226, Pg 206-212, 2020.
- [3] KP Kirui, DK Murage, PK Kihato: *Impacts of Placement of Wind Turbine Generators with Different Interfacing Technologies on Radial Distribution Feeder Fuse-Fuse Protection Coordination Scheme*. European Journal of Engineering Research and Science (EJERS), ISSN: 2506-8016, 4(10), Pg 59-77, 2019.
- [4] KP Kirui, DK Murage, PK Kihato: *Impacts of Short Circuit on Wind Turbine Generator Interfaced Radial Distribution Feeder Sequence Impedances*. Proceedings of sustainable research and innovation conference. JKUAT, ISSN: 2079-6226, Pg 250-255. 2019
- [5] Thomas P. Smith, "The ABC's of Over-current Coordination-Analyzer" Published for electrical engineers by E POWER ENGINEERING. January 2006. Technical report.

- [6] Tasha Harvey “Selective Coordination for Over-Current Protective Devices: Application for Buildings in the United States” Kansas state university, master’s Thesis 2012.
- [7] EDWIN PHO “Over-current Coordination Study” California Polytechnic State University, 2009.
- [8] Square D “Guide to Power System Selective Coordination 600V and below” Schnelder electric 2006. Technical report.
- [9] Thomas Gallery, Laura Martinez and Danijela Klopota “Impact of Distributed Generation on Distribution Network Protection” ESBI Engineering & Faculty Management, Ireland
- [10] W.H.Kersting “Radial Distribution Test Feeders” IEEE Power engineering society. Distribution systems analysis subcommittee report. 2000.
- [11] KP Kirui, DK Murage, PK Kihato: *Fuse-Fuse Protection Coordination Scheme ETAP Model for IEEE 13 Node Radial Test Distribution Feeder*. European Journal of Engineering Research and Science (EJERS), ISSN: 2506-8016, 4(9), Pg 224-234, 2019.

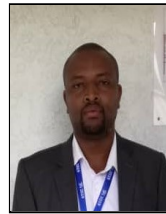

Mr Kemei Peter Kirui is a Kenyan born in Kiptere Location, Kericho County on 14th May 1983. He trained as an Electrical Engineer and graduated with a bachelor’s degree in Electrical and Communication Engineering from Moi University, Eldoret Kenya on 10th December 2009. He also trained in Technology Education and graduated with a PGDE in Technology Education from Moi University on 16th December 2014. On the year 2015, he joined Jomo Kenyatta University of Agriculture and Technology (JKUAT) for his Master of Science in Electrical and Electronic Engineering, Power Systems option specializing in Power Systems Transmission and Distribution Network Protection. He trained as an Energy Auditor with Kenya Association of Manufacturers (KAM) on 2016. He has also trained as a Power Systems Engineering Examiner with the Kenya National Examination Council (KNEC) on 2014.

He has worked for KNEC since 2014 to date as an Electrical Power Systems Engineering Examiner. He worked as a lecturer teaching Electrical Engineering at Zetech University Kenya on the year 2015 before proceeding to Moi University Eldoret, Kenya as an Assistant Lecturer in the department of Electrical and Electronic Technology where he works up to date.

Mr Kemei is a registered graduate engineer by the Kenya Engineers Registration Board (ERB). His areas of interest in research are: Power Systems Protection; Power Systems Distribution Networks Planning; Renewable Energy Technologies especially Wind Energy.